

# Digital Switch Display DP1001

Industry standard signals - integrated transmitter-supply - Potentiometer

## Features

- LED-Display 14,2 mm red
- Display range  $\pm 9999(0)$  Digit
- Indicating range and decimal point free programmable
- 2nd measuring input for difference, average value
- Max. 4 outputs, SPDT relays or transistor
- Isolated analog output  
0/4 ... 20 mA and 0/2 ... 10 V DC
- Front protection IP65



## General

The digital switch display novasens DP1001 is used to display measured values, which are supplied from the base units novasens 2050 and novasens 2000. It is displayed either in °C when connecting to the infrared measuring pyrometer novasens 2050 or the output of the quantity of glue in % when connecting to the novasens 2000 Hotmelt application controller. At the same time the programmable alarm outputs can be used for switching operations. The connection of potentiometers is also possible. Indicating range and decimal point are free programmable in the range  $\pm 9999$  digit (standard) or  $\pm 99990$  (fixed zero selected).

## Short information

Programming	Parameters are programmed via front-side membran keypad.
Alarm outputs	Switching performance min. or max. programmable, hysteresis, on delay time and off-delay time are programmable in range from 1s up to 9h.
Digital filter	With activated digital filter last measured values will be averaged continuously and the result is shown in the display.
Analog output	Proportional to the input signal an isolated analog output signal 0 ... 20 mA/0 ... 10 V DC or 4 ... 20 mA/2 ... 10 V DC can be generated. Output changes automatically from current signal to voltage signal depending on burden. ( $>500 \Omega \rightarrow$ Voltage).
2nd measuring input*	The device can be offered with a 2nd measuring input at the terminal strip B, for measuring difference-, average value, smaller or larger value. Please ask for further information. <b>*Note:</b> no isolation between input 1 (terminal strip A) and 2nd measuring input.

## Technical Data

### Supply voltage

Supply voltage: 230 V AC  $\pm 10\%$ ; 115 V AC  $\pm 10\%$ , 24 V AC  $\pm 10\%$  or 24 V DC  $\pm 15\%$

Power consumption: max. 3,5 VA, with analog output 5 VA

Operating temperature: -10 ... +55 °C

Rated voltage: 250V~ acc. VDE 0110 between input/output/voltage supply

Degree of pollution 2, over-voltage categoric III

Test voltage: 4 kV~, between input/output/supply voltage

CE-conformity: EN55022, EN60555, IEC61000-4-3/4/5/11/13

### Input

Current input: 0/4 ... 20 mA  $R_i = 10 \Omega$

Voltage input: 0 ... 10 V  $R_i = > 100 \text{ k}\Omega$

Potentiometer: 0 ... 1 k $\Omega$ /100 k $\Omega$

Accuracy:  $< 0,1\% \pm 2$  Digit

Temperature coefficient: 0,004 %/K

Transmitter-supply: U0 appr. 24 V,  $R_i$  appr. 150  $\Omega$ , max.50 mA (25 mA with 4 Relay outputs)

**Display:** LED red 14,2 mm

Display range:  $\pm 9999(0)$  digit mit leading zero suppression

Parameter display: LED 2-digit red, 7 mm (parameter - and output indicator)

### Output

Relay: SPDT  $< 250 \text{ V AC} < 250 \text{ VA} < 2 \text{ A}$ ,  $< 300 \text{ V DC} < 50 \text{ W} < 2 \text{ A}$

Transistor: max. 35 V AC/DC max. 100 mA, short circuit protected

Analog output: 0/4 ... 20 mA burden  $\leq 500 \Omega$ ; 0/2 ... 10 V burden  $> 500 \Omega$ , isolated

Automatic output changing (burden dependent)

Accuracy: 0,1 %; TK 0,01 %/K

**Panel case:** DIN 96x48 mm, material PA6-GF; UL94V-0

Dimensions: Front 96x48 mm, mounting depth 100 mm,

Weight: max. 390 g

Electrical Connection: Clamp terminals, 2 mm<sup>2</sup> single wire, 1,5 mm<sup>2</sup> flexible wire, AWG14

Protection: Front IP65, terminals IP20, fingersafe acc. German BGV A3

## Dimensions

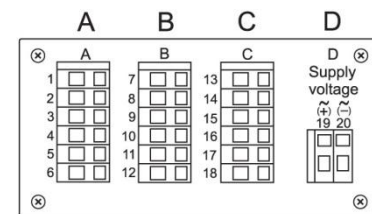
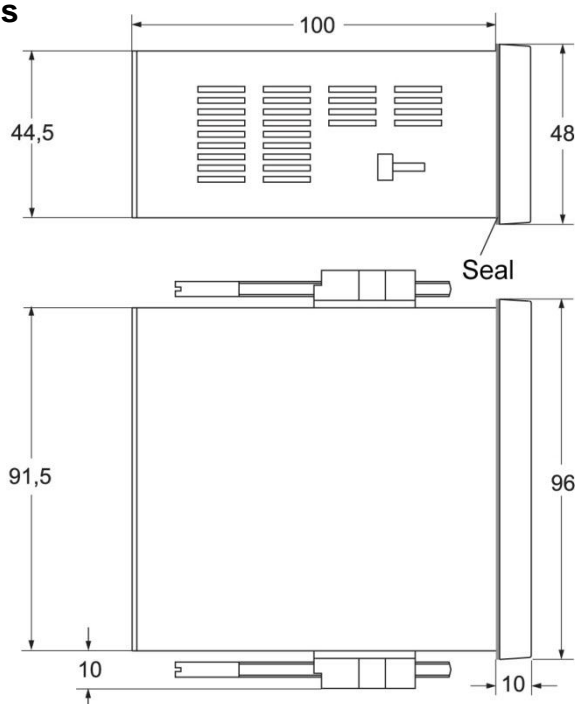

Terminal strip position

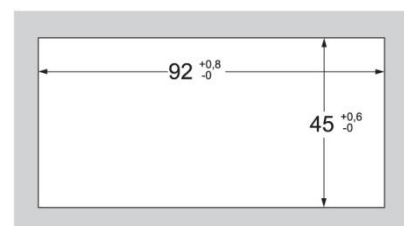

Panel cut-out acc. to  
DIN 43700-96x48

## Connection diagrams

### Terminal strip A

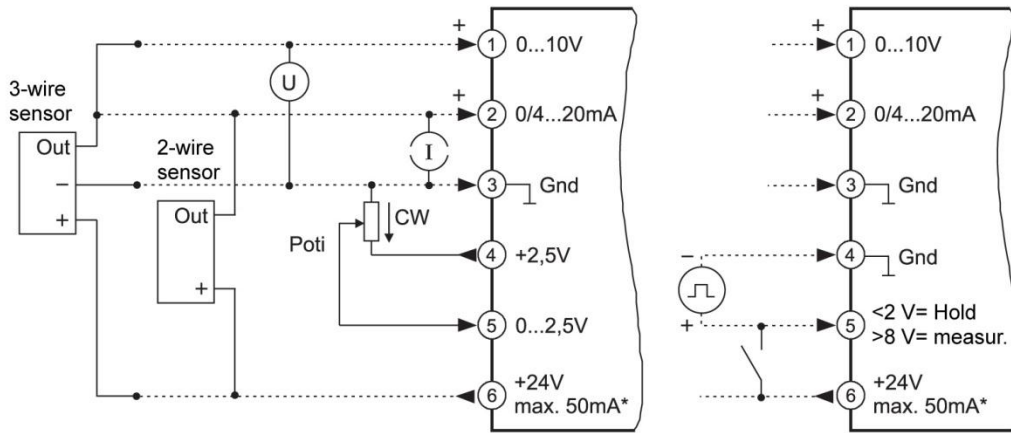

\*Transmitter supply

### Terminal strip B (varies with version)

2 alarm outputs

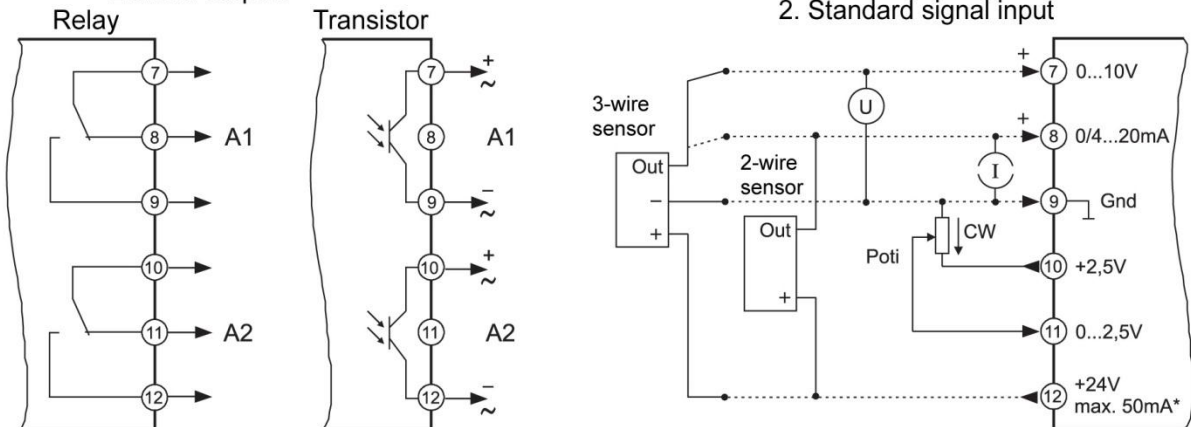

### Terminal strip C (varies with version)

2 alarm outputs

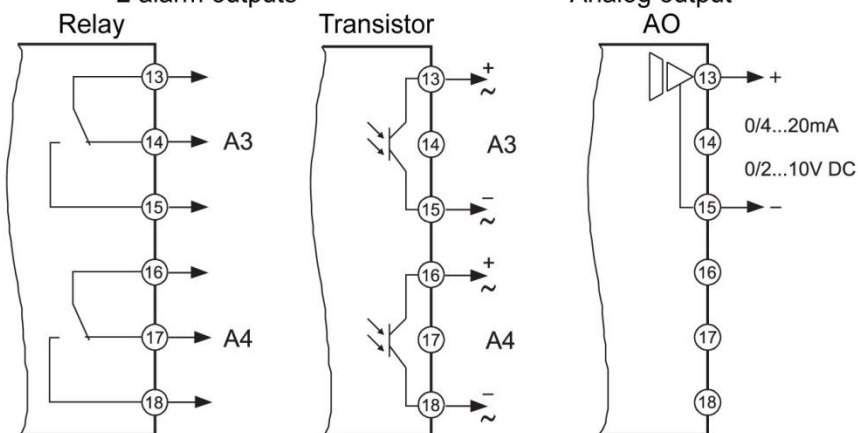

### Terminal strip D supply voltage (varies with version)

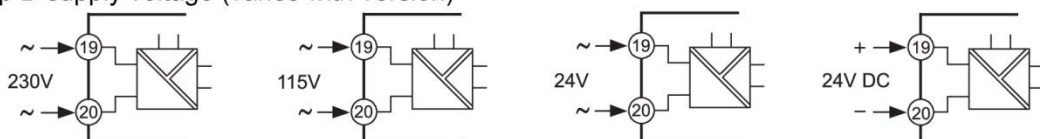

## Controls and indicators

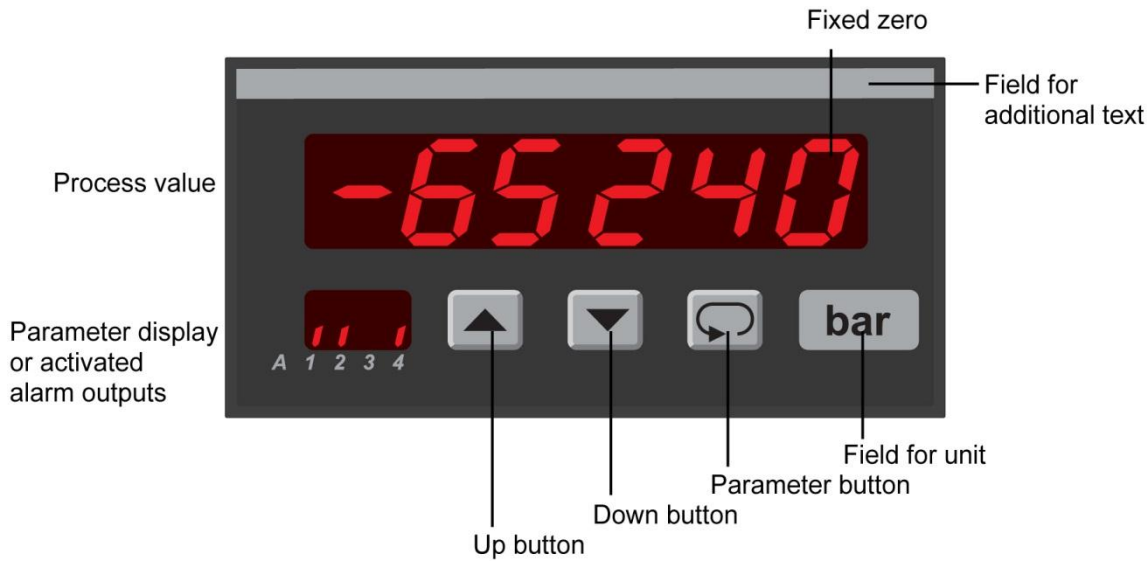

### Description

Operation of the device is arranged in 2 levels. While programming, pressing the button saves the current parameter and moves to the next programming step. For selection within a parameter or for entering data, use buttons ▲ and ▼.

After powering up, the device is located in the **Working level**. The displays shows the message *l.u.t.*

Set points of the alarm outputs can be preselected if available.

Pressing the button for more than 2 seconds, activates the **Configuration level**.

Now all the parameters which defines the function of the panelmeter can be programmed.

After finishing the configuration or when no button was pushed for more than 2 minutes, the program returns to the working level. Leaving the configuration level is possible at any time by pressing the button for more than 2 seconds.

Parameter display as status indicator for the alarm outputs A1- A4.

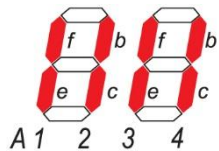

Segments f (A1 / A3) bzw. b (A2 / A4) are flashing with 2 Hz, when delay time is active.

Segments e (A1 / A3) and/or c (A2 / A4) are output indicators.

### Error codes:

Display flashes

**Err.or. l.**

If the measured signal is more than 3% out of the programmed span, or the A / D converter is overdriven, the display flashes with 1Hz.

**Err.or. l.** EEPROM Test. If a program error has occurred the message *Err.or. l.* shows in the display. When pushing the button ▲ a copy of the EEPROM will be loaded and the device will work with the factory settings. If this copy does not work, please ship the panelmeter to factory for repair service.

**L.o.c.**

Programming lock (see configuration page 7)

### Start-up note:

Before setting into operation, the device must be configured for the intended use (see page 6).

**Notes to representation**











Parameter is only displayed when configured

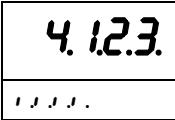
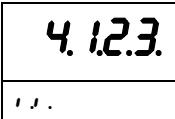

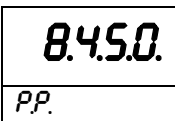
Parameter is only displayed when feature is included

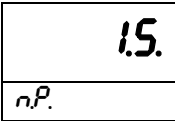

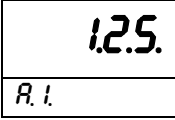







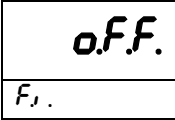



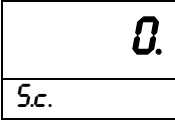



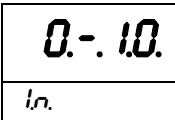



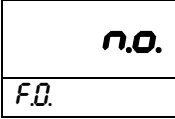

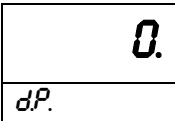

**Please note:** All parameters can be called if they are not blocked by other programmed parameters and if they are available.  
Factory settings are shown in the display.

**Working level**

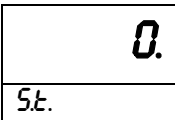
Button	Display	Description
		Actual value. Alarm output indication (only if installed and activated).
↓		Display brightness (permant changing possible) Setting in 9 steps with buttons ▲ and ▼.
		
↓		Peak memory Display maximum reading Reset with buttons ▲ or ▼ or at every power off.
		
↓		Peak memory Display minimum reading Reset with buttons ▲ or ▼ or at every power off.
		
↓		Setpoint output A1 Setting possible from 5.ℓ. (Start) ... E.n. (End) with buttons ▲ and ▼ . 5.ℓ. (start value) ... E.n. (end value)
		

**Note:** Settings of alarm outputs A1 to A4 are identical.

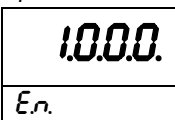
## Configuration

Button	Display	Description (Display graphic shows factory settings)
 2s Press	1  <i>OFF.</i> <i>F.</i>	Digitalfilter <i>o.F.F.</i> , <i>a.n.</i> Averaging of the last 16 measured values continuously. Selection with buttons  and  .
 	2  <i>0.</i> <i>Sc.</i>	Indicating correction Setting possible from <i>-99</i> ... <i>99</i> digit with buttons  and  .
 	3  <i>0-10.</i> <i>In.</i>	Selection of the input signal. <i>0-10.</i> ; <i>0-20.</i> ; <i>4-20.</i> ; <i>Pot.</i> Selection with buttons  and  .
 	4  <i>n.o.</i> <i>F.O.</i>	Fixed zero <i>0</i> , e.g <i>36.90 + 0</i> . <i>n.o.</i> ; <i>4E5</i> . Selection with buttons  and  .
 	5  <i>0.</i> <i>dP.</i>	Decimal point position <i>F.O. = n.o.</i> <i>0.</i> <i>0.</i> <i>00.</i> <i>000.</i> <i>F.O. = 4E5.</i> <i>0.</i> <i>00.</i> <i>000.</i> <i>0000.</i> Selection with buttons  and  .
 	6  <i>0.</i> <i>St.</i>	Start value for indicating range and analog output Setting possible from <i>-9999</i> ... <i>9999</i> digit with buttons  and  . In case of modification a new configuration of the alarm outputs is necessary.
 	7  <i>1000.</i> <i>En.</i>	End value for indicating range and analog output. Setting possible from <i>-9999</i> ... <i>9999</i> digit with buttons  and  . In case of modification a new configuration of the alarm outputs is necessary. If <i>St.</i> > <i>En.</i> , output works with a decreasing characteristic.



8

<b>o.F.F.</b>
R. I.

Switching performance output A1  
Function *o.F.F.* ; *o.n.r.* (min); or *o.n.u.* (max)  
If activated the start value will be loaded for set point.  
Selection with buttons ▲ and ▼.



9

<b>0.</b>
R. I.

Set point output A1  
Setting possible from *5.t.* (start value) ... *ε.n.* (end value)  
with buttons ▲ and ▼.



10

<b>1.0.</b>
H. I.

Hysteresis A1  
Setting possible from *1* ... *9.9.9.9*. Digit with buttons ▲ and ▼.



11

<b>1.0.</b>
t. I.

Switch-on delay output A1  
Setting possible from *0.00.00* ... *9.00.00* (h.mm.ss)  
with buttons ▲ and ▼.



12

<b>1.0.</b>
t. I.

Switch-off delay time output A1  
Setting possible from *0.00.00* ... *9.00.00* (h.mm.ss)  
with buttons ▲ and ▼.



**Note:** The parameterization for A2 ... A4 is like in A1



13

<b>0.-2.0.</b>
R.o.

Analog output  
*0. - 2.0.* mA (0 - 10 V DC) or *4. - 2.0.* mA (2 - 10 V DC).  
Changing from current to voltage output is load-dependent  
(≤ 500 Ω = current output, > 500 Ω =voltage output).  
Selection with buttons ▲ and ▼.



14



<b>0.</b>
R.5.

Analog output start value (Option 08)  
Setting possible from *5.t.* ... *ε.n.* of the display range  
with buttons ▲ and ▼.



15  
**1000.**  
*RE.*

Analog output end value (Option 08)

Setting possible from *S.t.* ... *E.n.* of the display range with buttons  and .

Note: If the display range would be changed afterwards, the range of the analog output get the same values.

Start- and end value of the analog output can be set anywhere in the display range. If *RE.* > *RS.* the output works with a decreasing characteristic.



16  
**00.**  
*Co.*

Code for factory settings.



17  
**oFF.**  
*Lc.*

Programming lock

**oFF.** : no lock

**CoNF.** : configuration level locked

**ALL.** : all parameters locked

Selection with buttons  and 



**4.123.**  
*... ..*

Return to the working level



**Ordering code**

The novasens DP1001 comes with the following equipment  
(Designation of terminal strip C optional):

**1. Terminal strip A**

1 Input signal 0-20mA, 4-20mA, 0-10 Volt  
(Output signal of the novasens Controller)

**2. Terminal strip B**

2R 2 Alarm outputs Relay

**3. Terminal strip C (Optional)**

AO Analog output 0-20mA, 4-20mA, 0-10Volt, isolated

**4. Terminal strip D supply voltage**

0	230 V AC	± 10 %	50-60 Hz
1	115 V AC	± 10 %	50-60 Hz
4	24 V AC	± 10 %	50-60 Hz
5	24 V DC	± 15 %	

**5. Options**

00	Without option
01	Min- and Max-value hold
02	Difference-, average value, larger value, smaller value
07	Display brightness programmable
08	Analog output separately programmable in the display range
14	Input for ext. hold signal
19	Measuring interval 32 ms (not available with all versions, please request)

This equipment is ideal for most measurement and switching tasks. There are further options and configurations available for specific measurement tasks

Subject to change.